

FIELD REPLACEABLE UNIT DOCUMENTATION

Satellite™ **5100 Series**

GENERAL INFORMATION

Tools Required for Proper Disassembly and Reassembly:

- 1. Phillips Screwdriver (Size 1)**
- 2. 3mm Flat head Screwdriver**
- 3. Case Separator**
- 4. ESD Wrist Strap**
- 5. ESD mats**
- 6. Tweezers**

Before attempting any of the following procedures, make sure that the main battery and AC adaptor is not connected to the unit and the environment in which you are working on is protected from Electro-Static Discharge(ESD).

FIELD REPLACEABLE UNIT DOCUMENTATION

SatelliteTM **5100 Series**

TABLE OF CONTENTS:

- 1. BATTERY PACK REMOVAL**
- 2. OPTIONAL PC CARD REMOVAL**
- 3. HDD REMOVAL**
- 4. MEMORY MODULE REMOVAL**
- 5. MINI PCI CARD REMOVAL**
- 6. MODEM BOARD REMOVAL**
- 7. KEYBOARD REMOVAL**
- 8. TOP COVER REMOVAL**
- 9. CD-R/W/DVD-ROM DRIVE REMOVAL**
- 10. SPEAKER(WOOFER) REMOVAL**
- 11. SOUND BOARD REMOVAL**
- 12. BATTERY BOARD REMOVAL**
- 13. RTC REMOVAL**
- 14. SECURE DIGITAL(SD) BOARD REMOVAL**
- 15. VIDEO BOARD REMOVAL**
- 16. COOLING MODULE REMOVAL**
- 17. CPU REMOVAL**
- 18. SYSTEM BOARD REMOVAL**
- 19. TOUCHPAD REMOVAL**
- 20. INTERFACE BOARD REMOVAL**
- 21. CD CONTROL/SUB LCD REMOVAL**
- 22. SENSOR SWITCH REMOVAL**
- 23. SPEAKERS REMOVAL**
- 24. 15" DISPLAY MASK REMOVAL**
- 25. FL INVERTER AND 15" LCD REMOVAL**

TOSHIBA

Tough Enough for Today's World

FIELD REPLACEABLE UNIT DOCUMENTATION

SatelliteTM 5100 Series

BATTERY PACK REMOVAL



Battery pack

1. Turn the computer upside down as shown.
2. Slide the **battery release lever** in the direction of the arrow.
3. Lift out the **battery pack**.
4. Separate the battery pack from the battery cover.

OPTIONAL PC CARD REMOVAL



PC Card

Eject button

1. Press the **eject button** of the PC Card you want to remove.
 2. Press the extended **eject button** to pop the **PC card** out slightly.
 3. Grasp the **PC Card** and pull it out
- NOTE:** Before removing any PCMCIA device, make sure it is "STOPPED" in the PC Card Manager.

HDD REMOVAL



M2.5x4 black flat head screw

1. Turn the computer upside down.
2. Remove **one M2.5x4 black flat head screw** securing HDD slot cover and pull out the **cover**.



HDD bracket handle

HDD assy

3. Grasp the **HDD bracket handle** and pull to disconnect the HDD assembly.
4. Lift the **HDD assembly** out of the HDD bay.

FIELD REPLACEABLE UNIT DOCUMENTATION

Satellite™ 5100 Series

HDD REMOVAL

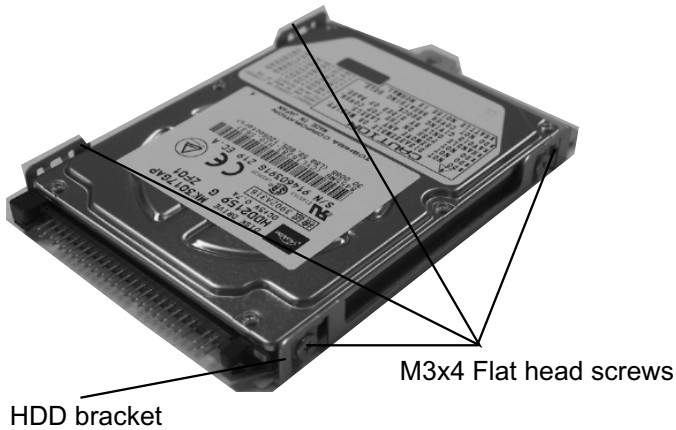

5. Remove **four M3x4 brass flat head screws** securing the HDD bracket to the drive.

MEMORY MODULE REMOVAL

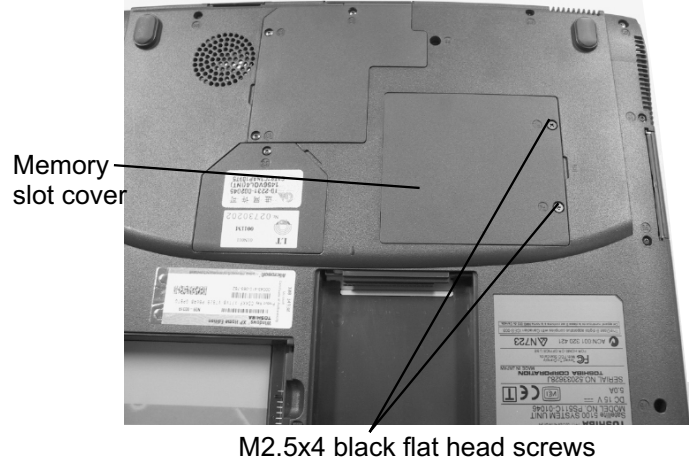

1. Turn the computer upside down.
2. Remove **two M2.5x4 black flat head screws** securing the memory cover.
3. Lift out the **cover**.

MEMORY MODULE REMOVAL

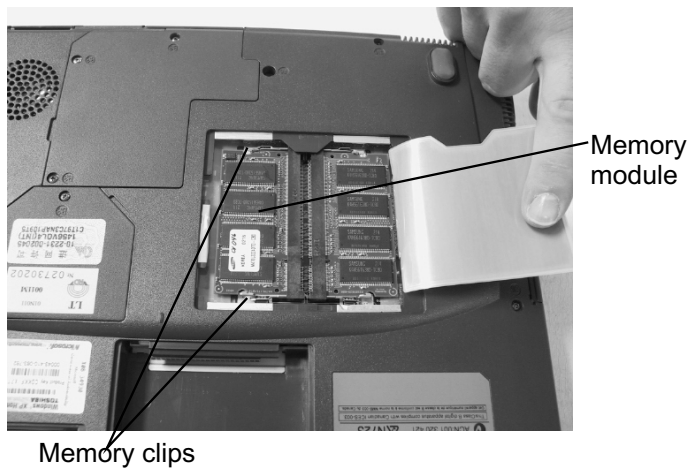

4. Gently press out on the **memory clips** and pull the memory module out of the connector on a 30 degree angle.

MINI PCI CARD REMOVAL

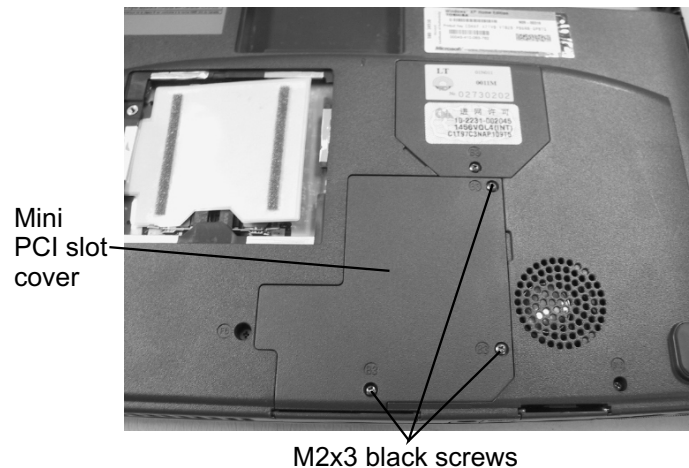

1. Turn the computer upside down.
2. Remove **three M2x3 black screws** securing the Mini PCI slot cover.

FIELD REPLACEABLE UNIT DOCUMENTATION

Satellite™ 5100 Series

MINI PCI CARD REMOVAL

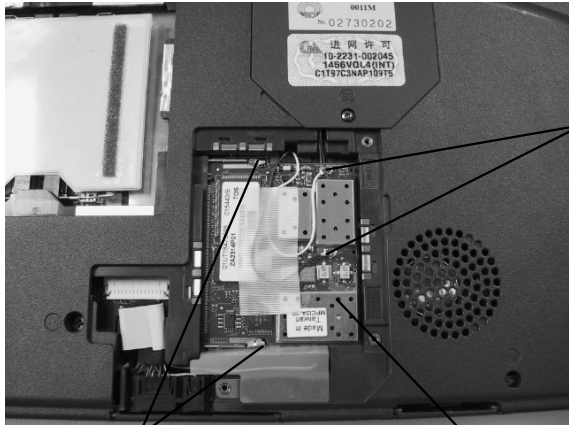

Black/white
mini coax

PCI clips

Wireless LAN card

3. Disconnect the **black and white coax cables** from the mini PCI wireless LAN card.
4. Gently press out the **Mini PCI slot clips** and pull the **Mini PCI wireless LAN card** out of the connector on a 30 degree angle.

NOTE: The mini PCI wireless LAN card is optional for the 5100 series.

MODEM BOARD REMOVAL



Modem slot cover

M2x3 black flat head screws

1. Remove **one M2x3 black screw** securing the modem slot cover.
2. Insert your finger nail or the case separator into the notched side of the cover and lift up to release the latch securing the modem slot cover.

MODEM BOARD REMOVAL

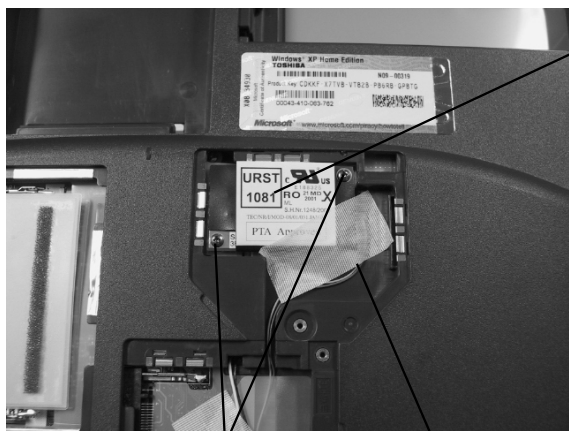

Modem



Latch

M2x3 black screws

MJ Harness

3. Disconnect the **MJ harness** from JP1 on the modem board.
4. Remove **two M2x3 black screws** securing the modem board.
5. Lift up the **modem board** to disconnect it from the system board.

KEYBOARD REMOVAL

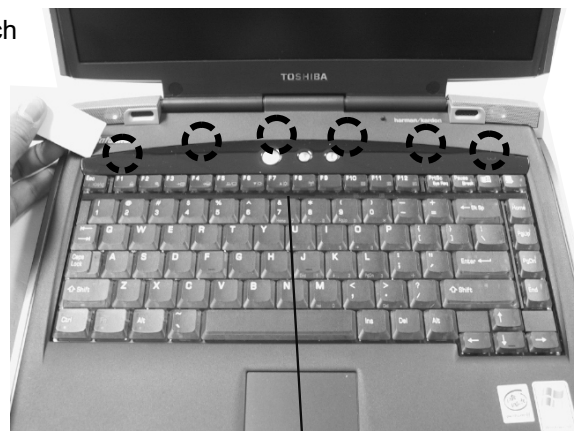

Keyboard holder

1. Open the display panel.
2. Remove the **keyboard holder** at the top of the keyboard.

TOSHIBA

Tough Enough for Today's World

FIELD REPLACEABLE UNIT DOCUMENTATION

SatelliteTM 5100 Series

KEYBOARD REMOVAL

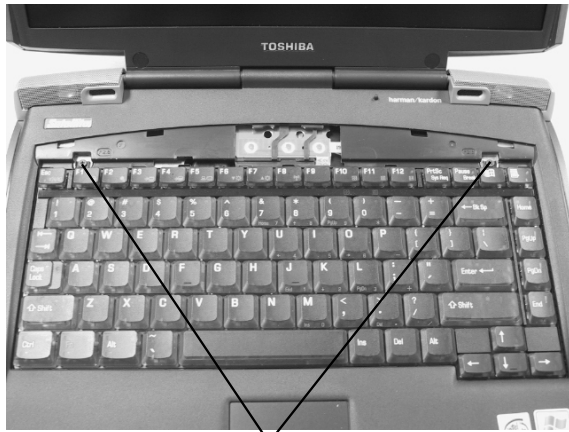

M2.5x2.8 black flat head screws

3. Remove **two M2.5x2.8 black flat head screws** securing the keyboard.

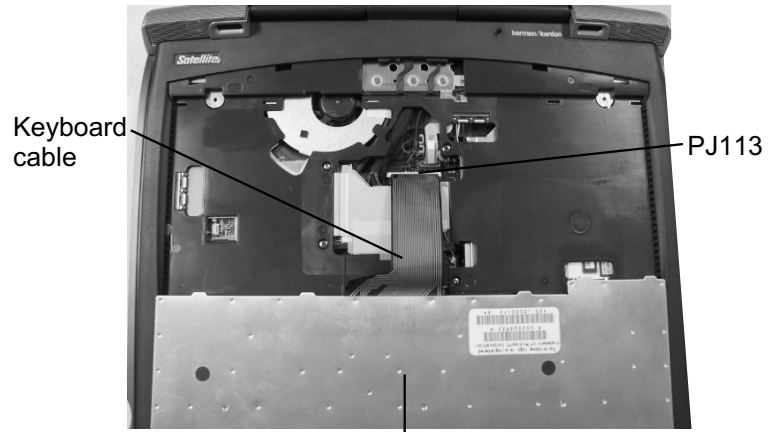

Keyboard cable

PJ113

Keyboard

4. Lift out the **keyboard** and set it on the palm rest.
5. Disconnect the **keyboard cable** from **PJ113** on the system board and lift out the keyboard.

TOP COVER REMOVAL



Modem/LAN harness

1. Turn the computer upside down.
2. Disconnect the **modem/LAN harness** from **PJ108** on the system board and remove it from the base assembly.

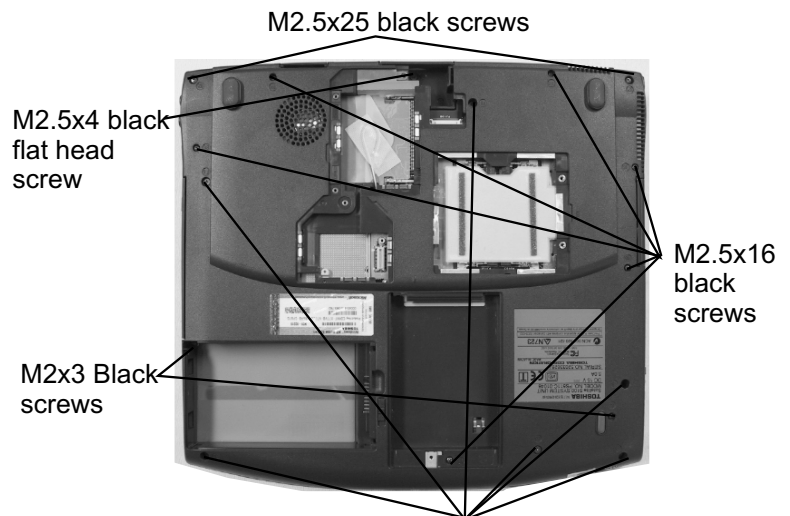

M2.5x25 black screws

M2.5x4 black flat head screw

M2.5x16 black screws

M2x3 Black screws

M2.5x6 black flat head screws

3. Remove the following seventeen screws from the bottom cover:
 - 6 **M2.5x16 black screws**
 - 2 **M2.5x25 black screws**
 - 6 **M2.5x6 black flat head screws**
 - 2 **M2x3 black screws**
 - 1 **M2.5x4 black flat head screw**

FIELD REPLACEABLE UNIT DOCUMENTATION

Satellite™ 5100 Series

TOP COVER REMOVAL

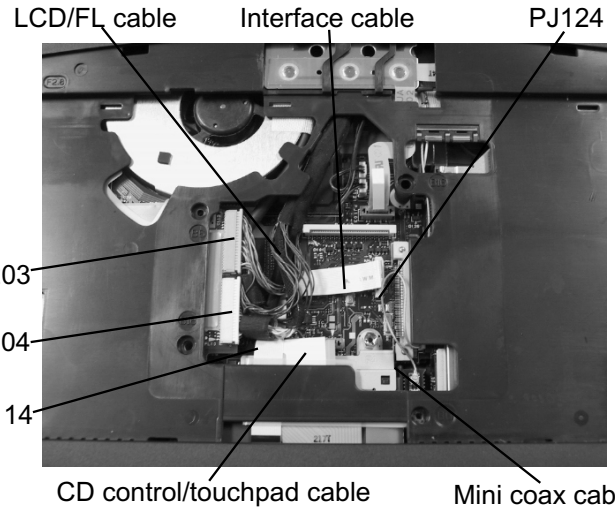
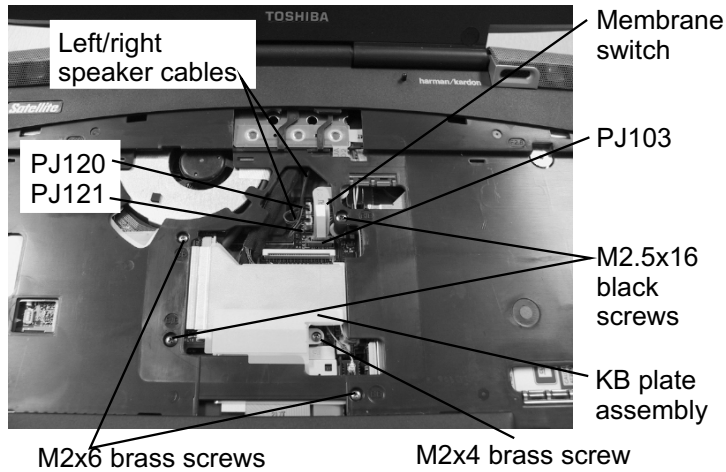

4. Turn the computer right side up and open the LCD panel.
5. Remove **one M2x4 brass screw** securing the KB plate and lift out the KB plate.
6. Remove **two M2.5x16 black screws** and **two M2x6 brass screws** securing the top cover.
7. Disconnect the **power/internet/in-touch/cover sensor membrane switch** from **PJ103**, the **left and right speaker cables** from **PJ120/PJ121** on the system board.

8. Disconnect the **LCD/FL cable** from **PJ203** and **PJ204** on the video board.
9. Disconnect the **mini coax cable** from the HDD/battery board.
10. Disconnect the **interface cable** and the **CD control/touch pad cable** from **PJ124** and **PJ114** on the system board. Lift out the top cover assembly.

CD-R/W/DVD-ROM DRIVE REMOVAL

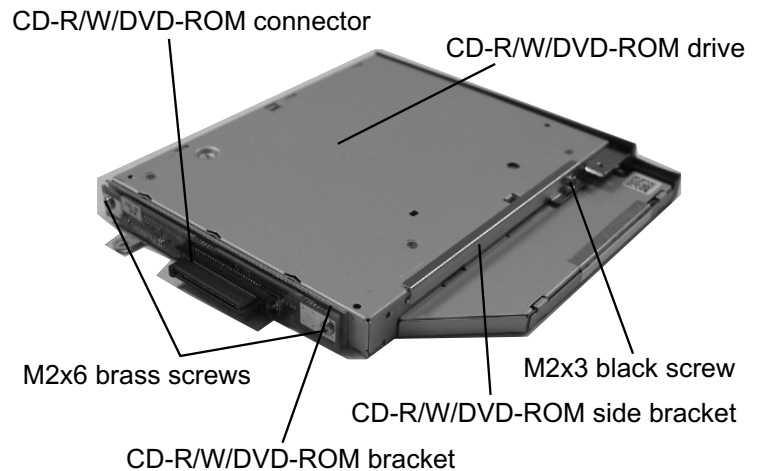

1. Slide the **CD-R/W/DVD-ROM drive** to the right to disconnect it from **PJ106** on the system board.

2. Remove **one M2x3 black screw** securing the side bracket and lift out the bracket.
3. Remove **two M2x6 brass screws** securing the CD-R/W/DVD-ROM connector and the bracket.
4. Remove the **connector** and the **bracket**.

FIELD REPLACEABLE UNIT DOCUMENTATION

Satellite™ 5100 Series

SPEAKER(WOOFER) REMOVAL

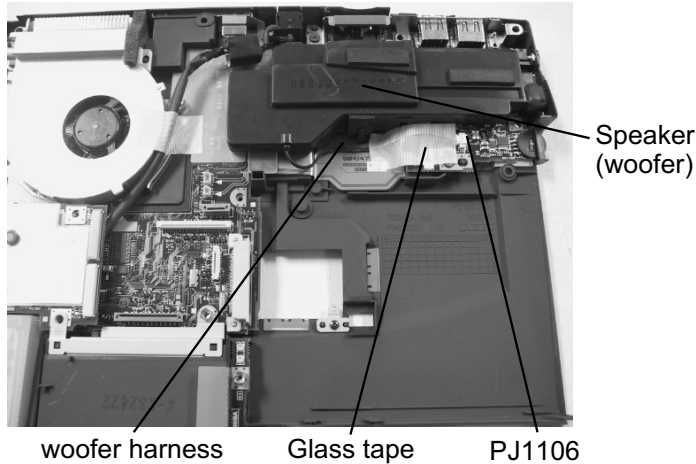

1. Peel off the **glass tape** securing the woofer harness.
2. Disconnect the **woofer harness** from **PJ1106** on the sound board.
3. Lift out the **speaker(woofer)**.

SOUND BOARD REMOVAL

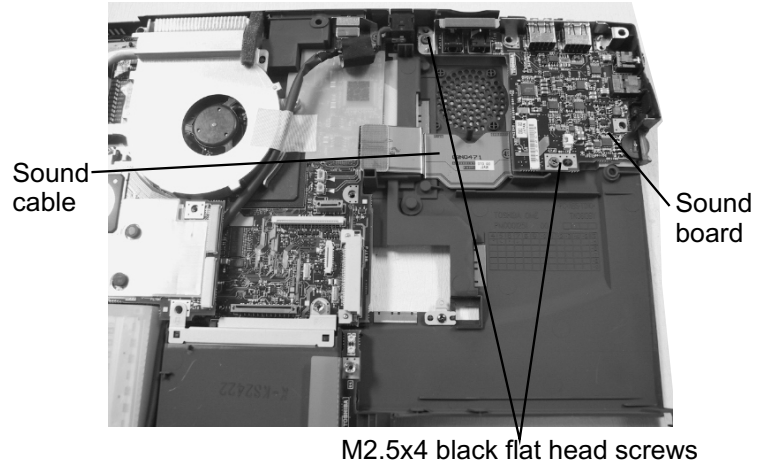

1. Remove **two M2x4 black flat head screws** securing the sound board.
2. Lift out the **sound board** and disconnect the sound cable (FMZFL1) from **PJ1100** on the sound board.

BATTERY BOARD REMOVAL

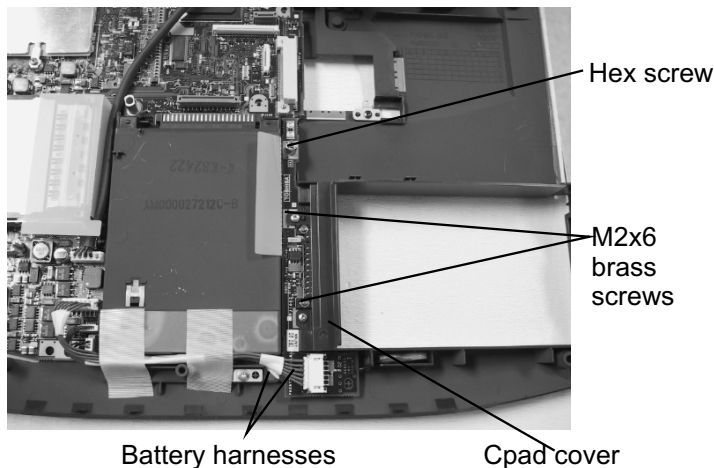

1. Remove **one hex screw** securing the battery board.
2. Remove **two M2x6 brass screws** securing the cpad cover and lift out the cover.
3. Disconnect the **two battery board harnesses** from **PJ1000** and **PJ10001** on the battery board.
4. Lift out the **battery board** assembly.

RTC REMOVAL

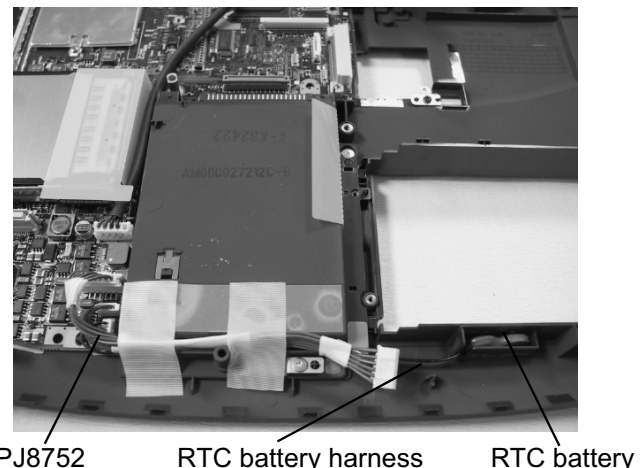

1. Remove the **glass tapes** securing the battery harness and RTC battery.
2. Disconnect the **RTC battery harness** from **PJ8752** on the system board.
3. Lift the **RTC battery** out of the slot.

FIELD REPLACEABLE UNIT DOCUMENTATION

Satellite™ 5100 Series

SECURE DIGITAL(SD) BOARD REMOVAL

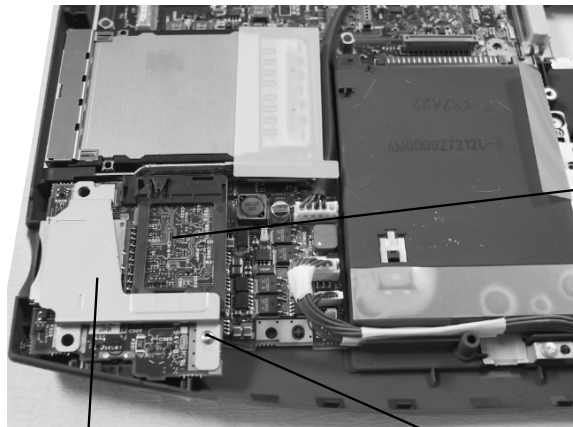

SD support plate M2x4 brass screw

1. Remove **one M2x4 brass screw** securing the SD support plate and the sound FIR board.
2. Remove the **SD support plate** and lift up the back side of the **sound/FIR board** to disconnect it from PJ601 on the system board.

VIDEO BOARD REMOVAL

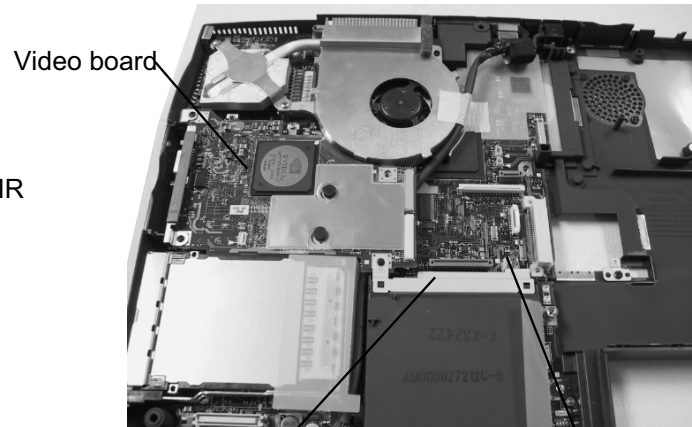

HDD con plate Hex screw

1. Remove **one hex screw** securing the HDD con plate and lift out the **plate**.
2. Disconnect the **video board** from system board.

COOLING MODULE REMOVAL

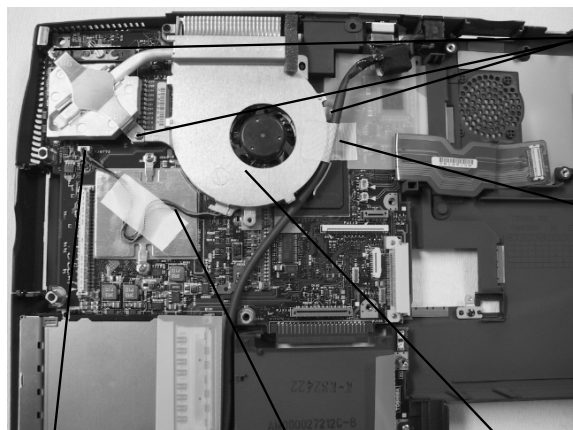

PJ8770 Fan harness Cooling module

1. Disconnect the **fan harness** from **PJ8770** on the system board.
2. Remove **three M2x8 brass screws** and securing the cooling module to the system board.
3. Peel off the **glass tape** securing the DC harness and lift out the **cooling module**.

CPU REMOVAL

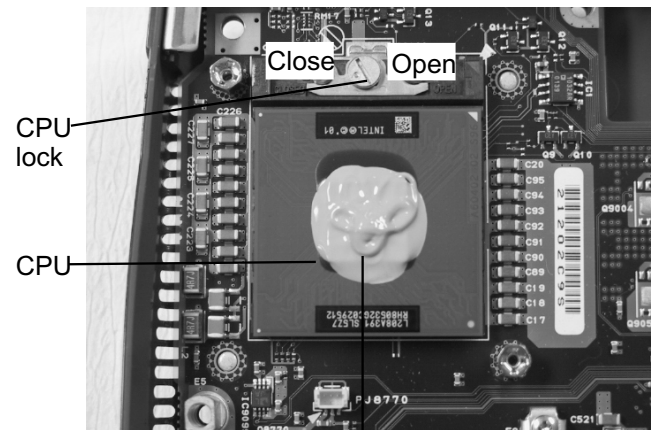

Silicone grease

1. Insert a **flat head screwdriver** in the **CPU lock** and rotate it counter-clockwise to unlock the **CPU**.
2. Lift out the **CPU**.

NOTE: When installing the CPU, make sure that a silicone grease is applied before attaching the heat sink. Please refer to FSB-200112 for the complete procedures on how to apply the silicone grease.

FIELD REPLACEABLE UNIT DOCUMENTATION

Satellite™ 5100 Series

SYSTEM BOARD REMOVAL



1. Disconnect the **DC-IN harness** from **PJ8800** on the system board and remove it.
2. Disconnect the **sound cable** from **PJ119** on the system board.
3. Disconnect the **battery harness** from **PJ8820** and **PJ8821** on the system board.

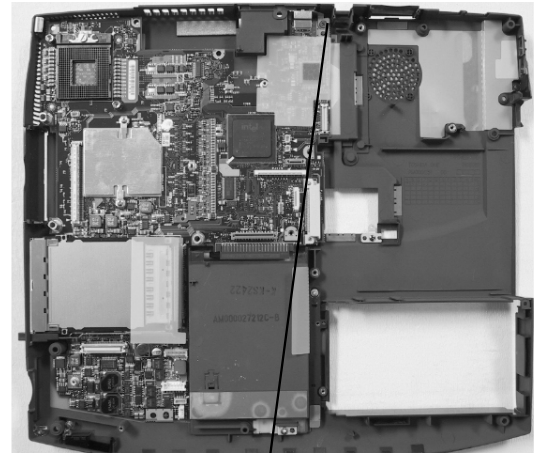

M2.5x4 flat head black screw

4. Remove **one M2.5x4 flat head black screw** securing the system board.
5. Lift out the **system board**.

TOUCHPAD BOARD REMOVAL

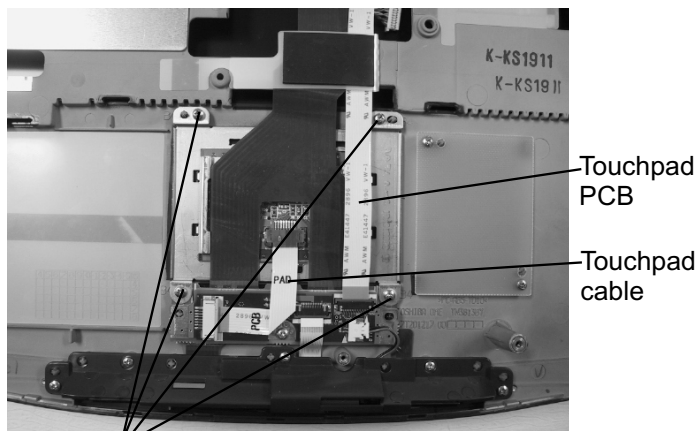

1. Disconnect the **touchpad cable** from the touchpad PCB.
2. Remove **four M2x4 brass screws** securing the touchpad assembly.
3. Lift out the **touchpad PCB**.

INTERFACE BOARD REMOVAL

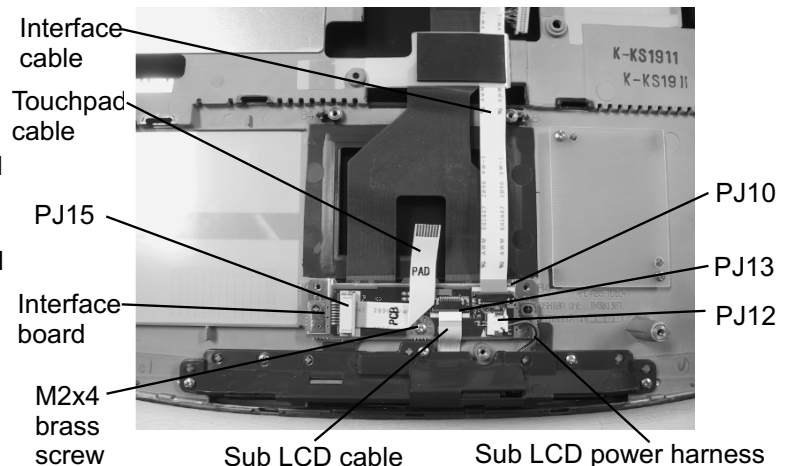

1. Disconnect the **touchpad cable** from **PJ15**, the **interface cable** from **PJ10**, the **sub LCD cable** from **PJ13** and the **sub LCD power harness** from **PJ12**.
2. Remove **one M2x4 brass screw** securing the interface board.
3. Lift out the **interface board**.

FIELD REPLACEABLE UNIT DOCUMENTATION

Satellite™ 5100 Series

CD CONTROL/SUB LCD REMOVAL

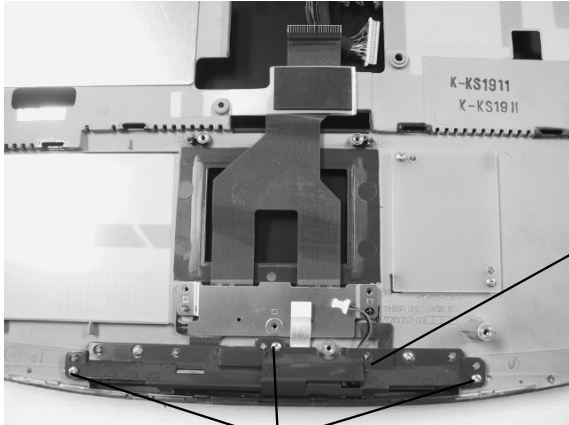

Button holder

M2x4 brass screws

1. Remove **three M2x4 brass screws** securing the button holder.
2. Lift out the **button holder**.

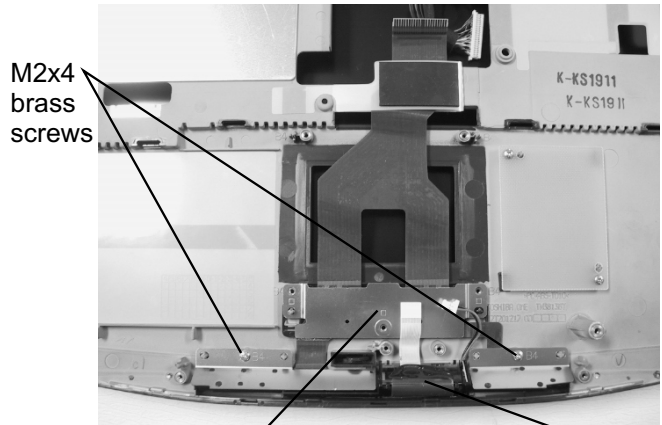

M2x4 brass screws

CD control/touchpad button assy

Sub LCD assy

3. Remove **two M2x4 brass screws** securing the CD control/touchpad button assembly.
4. Lift out the **CD control/touchpad button assembly**.
5. Lift out the **sub LCD assembly**.

SENSOR SWITCH REMOVAL



Sensor switch assy

M2x4 brass screws

1. Remove **four M2x4 brass screws** securing the sensor switch assembly.
2. Lift out the **sensor switch assembly**.

FIELD REPLACEABLE UNIT DOCUMENTATION

Satellite™ 5100 Series

SPEAKERS REMOVAL

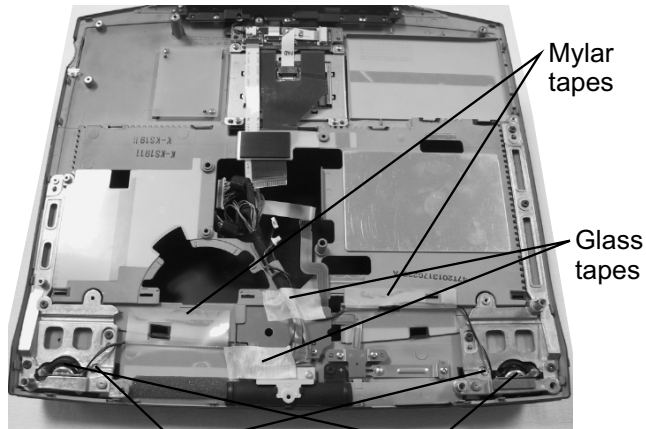

M2x6 brass screws Left and Right speakers

1. Peel off the **glass tapes** and **mylar tapes** securing the left and right speaker cables.
2. Remove **two M2x6 brass screws** securing the left and right speakers.

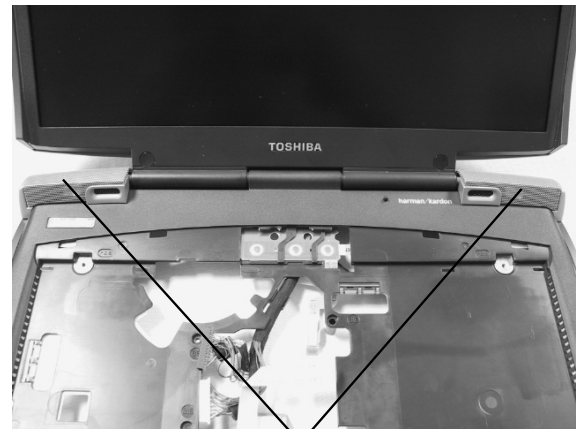

Left and Right speaker covers

3. Remove the **left** and **right speaker covers** and lift out the speakers.

FIELD REPLACEABLE UNIT DOCUMENTATION

Satellite™ 5100 Series

15" DISPLAY MASK REMOVAL

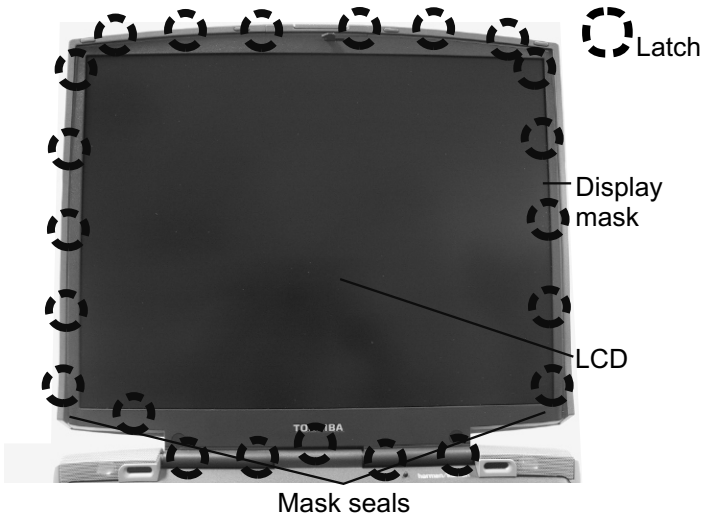

1. Remove **two mask seals** at the bottom corners of the display assembly using a pair of fine-tipped tweezers.
2. Remove **two M2.5x6 flat head brack screws** securing the display mask.
3. There are **22 latches** securing the **display mask**. Carefully insert your fingers between the mask and the LCD panel and pry open the latches starting from the **bottom six latches**, to the **five latches on the right and left sides**, ending with the **six toplatches**.

FL INVERTER AND 15" LCD REMOVAL

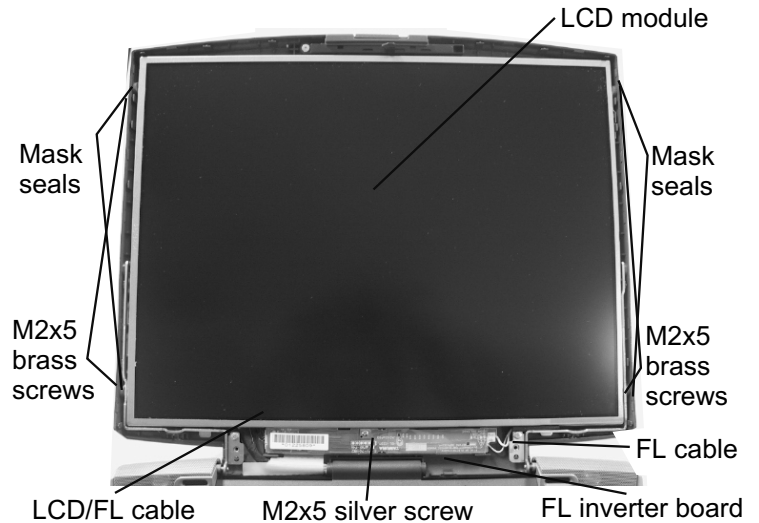

1. Remove **one M2x5 silver screw** securing the FL inverter board.
2. Carefully lift up the **FL inverter board** and disconnect the **LCD/FL cable** from **CN1** and the **FL cable** from **CN2**.
3. Remove **four mask seals** to expose four screws securing the LCD module assembly.
4. Remove **four M2x5 silver screws** securing the LCD module.
5. Carefully rotate out the top of the **LCD module** enough to access the display cable
6. Peel off the tape securing the LCD/FL cable and disconnect the cable.

TOSHIBA

Tough Enough for Today's World